

TriStar MPPT (150V and 600V) Wind Charging Control Info

Morningstar's TriStar MPPT controllers are designed for solar PV applications. However, Morningstar MPPT controllers are also compatible with other DC power sources such as higher voltage batteries, power supplies or wind and hydro turbines. Please review all operating parameters of the TriStar MPPT controllers to determine compatibility with any type of DC power source.

Please note: TriStar-MPPT-600V sales for wind are authorized for test purposes only unless authorized by Morningstar.

New Firmware updates may be available for the TriStar MPPT controllers. It is recommended that the latest version of the Firmware is used to ensure the best performance of the TriStar MPPT controllers. Please see the Product Support Page/ Software Tab to check for the latest updates of the Firmware and MSView™ software for the controller you are using.

TriStar MPPT 600V: http://support.morningstarcorp.com/search/?document_section=Software&search_product=92

Important: If there are system faults and alarms with the TriStar MPPT 600V controller please bring them to our attention at support@morningstarcorp.com.

TriStar MPPT (150V): http://support.morningstarcorp.com/search/?document_section=Software&search_product=96

Small wind and hydro turbines will typically generate power using a 3-Phase AC alternator. The AC power is then rectified to DC power.

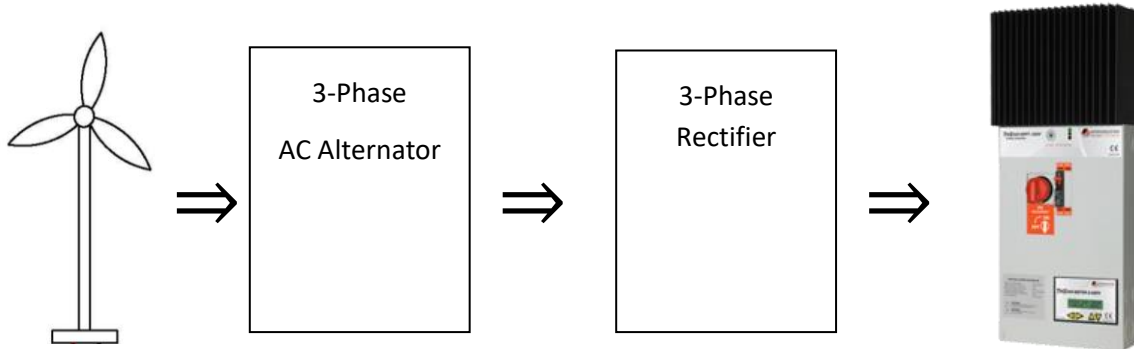

Figure 1: DC Power Generation from Turbine

The voltage and current will change with changing conditions. A small wind system can be highly variable with rapid voltage and power changes in response to wind gusts. The rectified DC power is often referred to as “wild DC” power. The TriStar MPPT controller will track the wild DC power and voltage of the turbine.

The TriStar MPPT (150V and 600V) setup includes a Voltage vs. Power curve to be entered for the turbine being used. The combination of voltage and power levels will form a piecewise linear curve. The TriStar MPPT controller continually adjusts the wild DC power input so it operates according to the voltage vs. power curve. As the power from the turbine increases the voltage increases to optimize the performance from the turbine.

Programming a voltage vs. power curve involves knowing the operational voltages of the turbine. This includes the cut-in voltage (or the voltage level which the turbine has enough rotational speed to start generating electric power). In addition, it includes the maximum power ramp up voltages, maximum voltage/power range and maximum open circuit voltages of the turbine. Voltage and power characteristics and requirements will be discussed further in the turbine and system requirements section of this paper.

TS-MPPT High Speed Tracking: One of the most important requirements of an MPPT controller for small wind is fast response time. Giving the turbine the optimal voltage and power at all times with no delays is critical for smooth performance to prevent electronic braking or over speed fluctuations of the turbine. The TriStar MPPT controller is known for its fast response time, capable of sweeping from open circuit voltage to battery voltage in a fraction of a second. The remarkable thing is that the TriStar MPPT 600V controller has an even faster response time even with the larger voltage window. The TriStar MPPT controllers were designed both for fast solar PV MPPT tracking and instantaneous voltage/power control for wind.

WARNINGS:

System Compatibility: It is necessary to review all operating parameters of the TriStar MPPT controllers to determine compatibility with any wind or hydro turbine. See the manual and information included in this document for details.

DAMAGE DUE TO OVER-VOLTAGES WILL NOT BE COVERED BY WARRANTY. It is the installer's or OEM's responsibility to prevent over-voltages from damaging to the controller. This includes momentary inductive surges due to the controller shutting off. Ginlong makes products designed to protect electrical equipment against over-voltages when it shuts off suddenly. http://www.ginlong.com/en/Ginlong_Controller.html?l=en Other products may also be available. Morningstar does not guaranty the performance of 3rd party products.

INPUT FUSE REQUIRED: 20A FUSE REQUIRED for 600V models. FUSE = Rated Output Current REQUIRED for 150V models. Over-voltage damage is more likely to be limited to the replacement of low cost parts when there is adequate overcurrent protection on the input.

WIND SETTINGS AND CUSTOM PROGRAMMING REQUIRED: DIP Switch 1 UP for Wind mode and Custom Programmed in Wind mode using the MSView™ TriStar MPPT 600V Setup Wizard. Input voltage and power settings must not start at zero and must both be listed in ascending order without repeating any values.

36V and 24V System Information: Systems designed for battery voltages less than 48V are subject to derated max. output current at lower voltages depending on battery voltage. See figure 3 TriStar MPPT 600V Input Voltage vs. Output Power graph for derating info.

SOLAR TRACKING MODE MAY DAMAGE THE CONTROLLER: Morningstar's TrakStar technology incorporates frequent sweeps of the input from open circuit to battery voltage. If the max. voltage surge for a given turbine can exceed the rated voltage of the TriStar MPPT controller (150V or 600V) damages can occur even with over-voltage protection installed.

Diversion Loads on DC Input: Diversion loads on the DC input, if used, must include a diode to protect the circuit from the possibility of back-feeding. See page 6 for more information.

Ripple Voltage due to rectified AC: Ripple voltages should always be minimized with the TriStar MPPT 150V controller. The TriStar MPPT 600V can operate effectively with ripple voltages. However, if peak voltage or power can ever exceed the max. operating limits it may be problematic intermittently causing over-voltage and over-current faults. Morningstar does not have information regarding how to reduce ripple from a rectifier.

Faults and Alarms: If there are system faults and alarms please contact Morningstar before further testing.

Important: See the TriStar MPPT (150V and 600V) Manuals for further details regarding wiring, installation and safety requirements.

The parallel input feature for larger turbines is not currently available. Any unauthorized testing of the TriStar MPPT with any type of parallel input is not currently supported and will not be covered by the warranty.

It is critical that the input voltage of the TriStar MPPT controllers never exceeds the rated max. input voltage of the controller (150V or 600V). The TriStar MPPT controllers' transistors can get damaged if exposed to voltages in excess of the rated input voltage, even if the transient is only microseconds in duration. The simplest solution is to use a turbine with a maximum open circuit voltage which cannot exceed the maximum input voltage rating of the TriStar MPPT controller (150V or 600V). Turbines which can potentially produce higher maximum open circuit voltages will require overvoltage protection which prevents any overvoltage under all circumstances. The turbine and system requirements section of the paper discuss overvoltage protection further.

The TriStar MPPT controller system will still require a means to keep the turbine's rotational speed under control during voltage regulation periods. It cannot simply start reducing power when the batteries are full since that would cause the rotational speed to increase out of control. One option is to use the TriStar controller in diversion mode. See Figure 2.

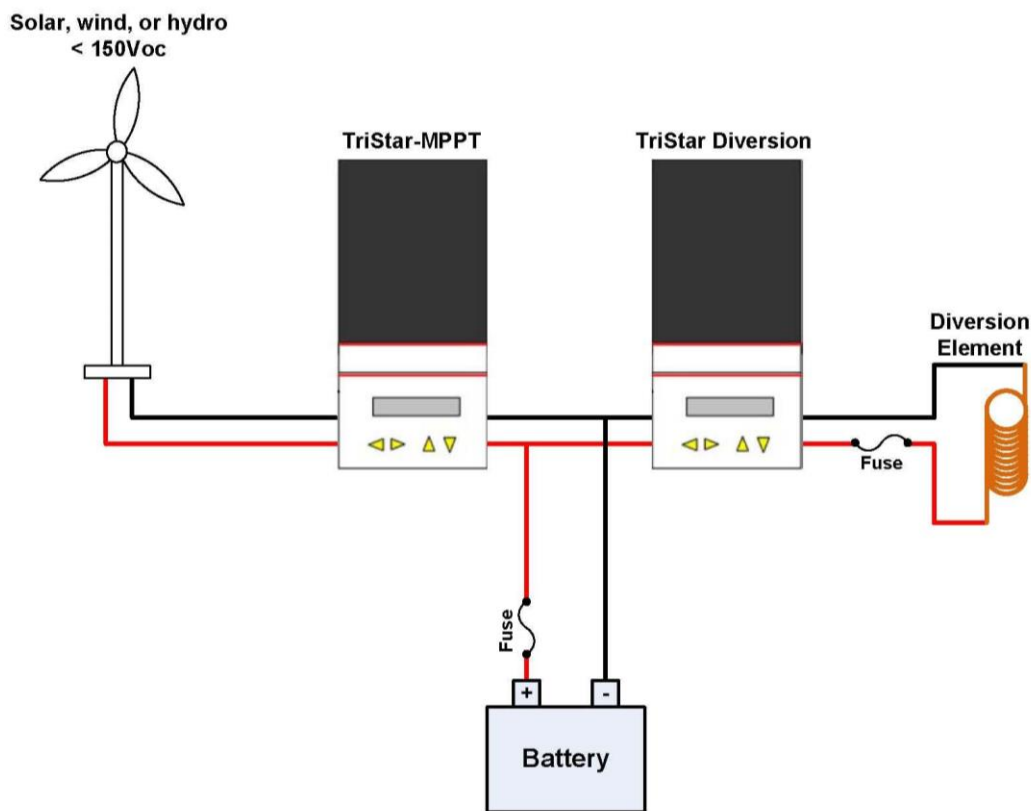

Figure 2: TriStar-MPPT/ TriStar Diversion System

The TriStar-MPPT/ TriStar Diversion System allows TriStar MPPT controller to operate at full power (bulk charging mode) continuously while the TriStar diversion controller handles the regulation voltage control. This will maintain continuous operation of the Voltage vs. Power Bulk charging MPPT operation at all times.

To set up a TriStar-MPPT/ TriStar Diversion System the TriStar MPPT controller(s) use higher regulation voltage settings than the TriStar diversion controller. The TriStar diversion controllers would be set up in the same manner as a typical nominal voltage diversion system would. The TriStar controllers will need to be able to divert the full output current from the TriStar MPPT controller(s). See the TriStar Diversion Control section of the TriStar Manual for further details on how to design and configure TriStar Diversion circuits. http://support.morningstarcorp.com/wp-content/uploads/2014/07/TS.APP_Diversion.01.EN.pdf

Applying diversion loads on the input or applying mechanical braking during voltage regulation instead of using the TriStar diversion at the battery is possible. However, these other methods can be problematic since it is difficult to match the gradual reduction in power required to regulate battery voltage. Keeping the turbine load for optimal rotational speed (with a clipper circuit or mechanical braking) while maintaining a steady power level for the TriStar MPPT during Absorption charging and Float phases is difficult to co-ordinate with rapid changes in power levels.

In addition to being able to keep the turbine under load during absorption charging an independent braking system will need to be able to shut down or keep the turbine loaded with a manageable rotational speed in case the TriStar MPPT controller shuts off. If the turbine has no furling or mechanical braking it will need some type of clipper circuit. This braking mechanism might be the same device that is used for overvoltage protection.

Turbine and System Requirements: Design Considerations

Operating Voltage vs. Power Window

What is the operating input voltage window for the TriStar MPPT (150V & 600V) controllers? In Wind mode, these controllers are designed to be able to start operating whenever the input voltage is greater than the battery voltage and the absolute maximum operating voltage is 145V for the TriStar MPPT (150V) controller and 525V for the TriStar MPPT 600V controller. In addition, the TriStar MPPT 600V controller's maximum operating input current (I_{in}) can be as low as ~8 Amps for $V_{in} < 100V$ and less than 15 Amps for $V_{in} > 100V$. At higher input voltages the TriStar MPPT controllers will derate to the maximum operating output current. It is important to consider that the maximum charging current will start to derate as the input voltage increases closer to the maximum operating input voltage.

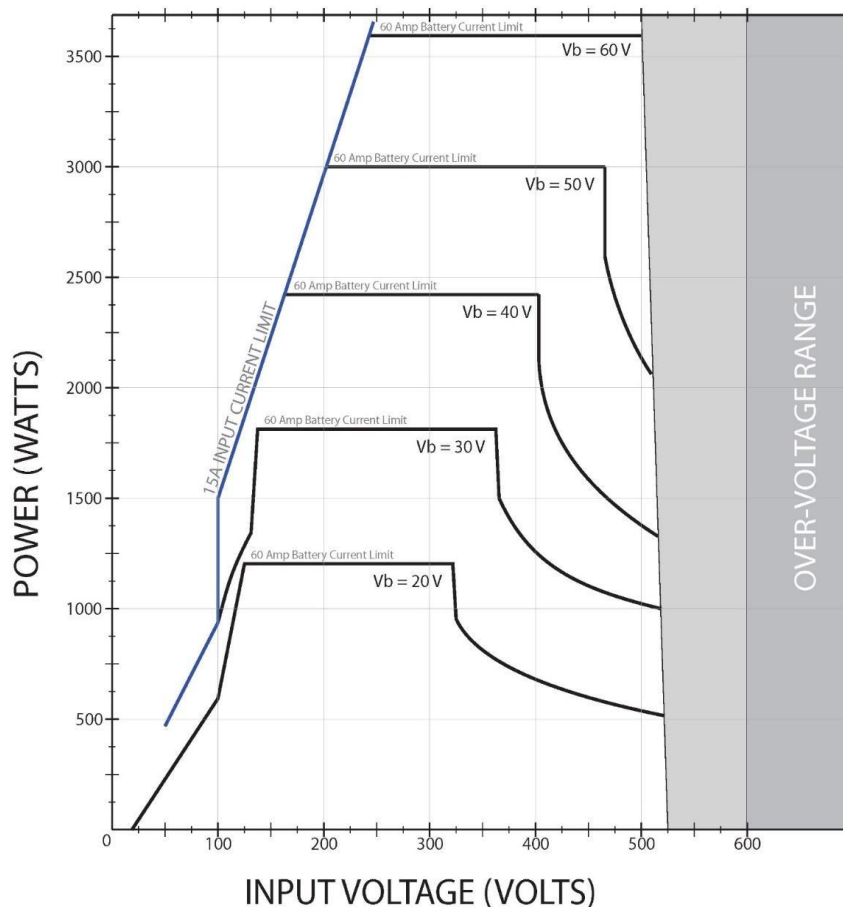

Figure 3: TriStar MPPT 600V Input Voltage vs. Output Power for Battery Voltages of 20-60V (10V increments)

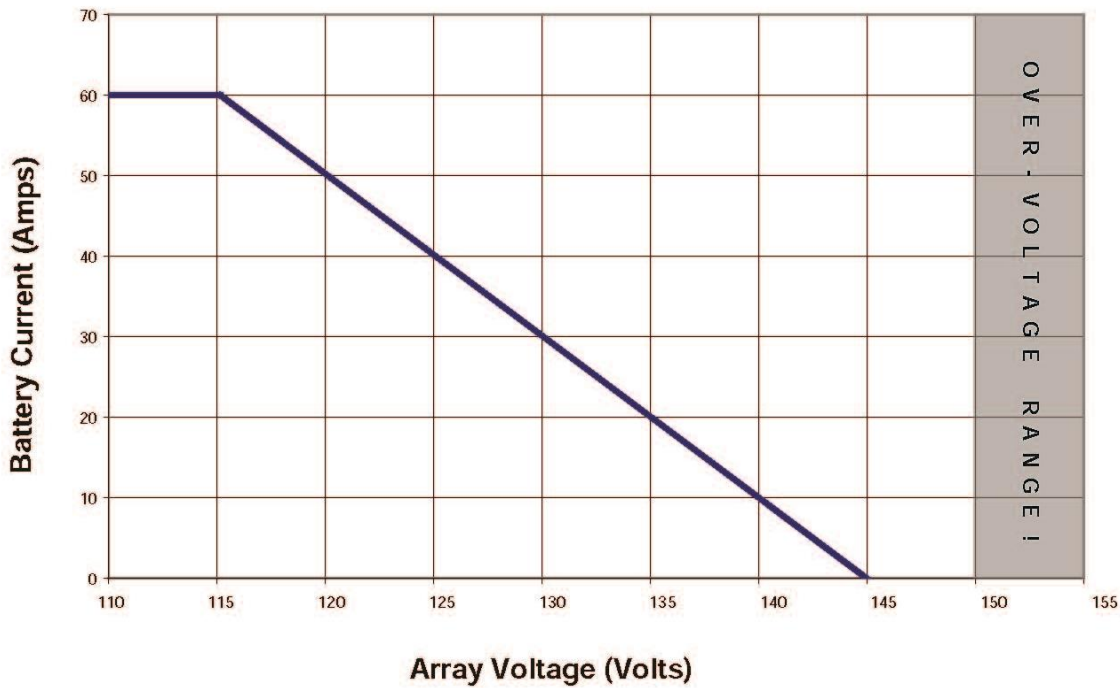

Figure 4: TriStar-MPPT (150V) Input Voltage vs. Battery current Derating

What are the maximum operating power levels for the TriStar MPPT controllers? The max. output charging power of the controllers is proportional to the battery voltage based on the maximum rated output current.

$$\text{Max. Charging Power (max. } W_b) = \text{Rated Output Current (max. } I_b) \times \text{Battery Voltage (} V_b)$$

Therefore, the lowest max. charging power for the controller when there is no derating is based on the minimum possible battery voltage during max. charging current operation (60A, 45A or 30A). Most battery based systems may have a low voltage disconnect (LVD) of 11.5V, 23V, 46V for a 12V, 24, 48V nominal voltages. However, battery voltages increase with high charging current. The minimum battery voltage during the full rated charging will depend on the battery size, maximum load and other factors. However, typically the minimum battery voltage should never be lower than the nominal voltage of the system (12V, 24V or 48V) when the controller is operating at the rated charging current.

$$\text{The battery charging power (} W_b) = \text{Input Power (} W_{in}) \times \text{Efficiency}$$

$$\text{Therefore, } W_{in} = W_b / \text{Efficiency}$$

This information can be used to determine the amount of power that the TriStar MPPT controllers can reliably process with wind and hydro turbines.

Example:

$$\text{Max. } I_b = 60A$$

$$V_b \text{ min. during charging} = 48V$$

$$W_b \text{ max. at } V_b \text{ min.} = 60A \times 48V = 2880W$$

$$\text{Max Efficiency at Full Power} = 96\%$$

$$W_{in} = 2880 / .96 = 3000W$$

It should be reasonable to expect the 60A TriStar MPPT controller to handle at least 3000 Watts of power from a turbine for a 48V nominal system. There may be other factors in the system that can affect the minimum voltage

including the size and health (age) of the batteries, larger loads which could reduce the voltage during charging or loads which have lower LVD settings. These factors should be taken into account to determine the minimum battery voltage and minimum operating input power for the system.

Turbine Requirements of the TriStar MPPT controllers

Ideally, the wind or hydro turbine will be able to operate within the operating limits for input Voltage and Power as shown in the proceeding section. For some wind turbines, peak power levels may exceed the maximum operating power of the controller with very strong wind gusts.

Power

The turbine will need to operate within the DC Voltage and Power limits from the proceeding section.

If the Max Power from the Turbine can exceed the lowest expected maximum input power (during lowest battery voltage) of the TriStar MPPT controller it may be necessary to implement some type of power reduction either mechanically or with a dump load on the input side of the TriStar MPPT controller.

- An AC Clipper is preferred since the diodes in the rectifier prevent reverse current.
- DC Diversion loads should only be implemented with a diode to prevent reverse current.
- If the mechanical response time (furling etc.) is not fast enough it may be possible to use an auto-disconnect switch to prevent overpower and overvoltages.

High Voltage

The derate curves shown in the high voltage range indicates the maximum operating voltages that might be considered. For a full power system that is expected to operate at the controller's full rated current the maximum operating current should stay below the point where the output current could start to derate. Derating might start as low as 115V for the TriStar MPPT (150V) and 460V for a TriStar MPPT 600V ($V_b \text{ min.} = 48V$).

High voltage limit clipper/diversion load switches can be used with dump loads to prevent freewheeling of the turbine which can prevent higher voltages during high wind speeds. These devices can operate so that the TriStar MPPT can continue to operate in the full power voltage range without derating. Many turbines also have mechanical loading or furling sometimes based on rotational speed rather than input voltages. The likelihood that the electrical or mechanical braking will slow down the controller before the voltage increases into derated power or a full shutdown of the controller will depend on the response time and the voltage or rotational speed settings. Gust levels and turbulence at the site can also play a role in how fast the wild DC voltage and power can change. Other mechanical and/or electrical factors can also affect the maximum possible voltage during the activation of the clipper or mechanical braking.

Overvoltage Protection

The electrical load is like a braking system for the turbine. It is critical that the electrical load is maintained continuously especially if there is no auto-furling or other mechanical braking system. High Voltage Clipping, or Diversion Load Switching on the input, is often used with small wind systems even those with mechanical braking systems to keep the rotational speed of the turbine under control during extremely strong gusts or at times when the power electronics (inverter or MPPT controller) shuts down.

Clipper/diversion loads must be used on the AC circuit before the rectifier rather than on the DC circuit after the rectifier unless a Diode is used at the input of the MPPT controller to prevent the possibility of any reverse current.

As with solar PV systems the maximum input voltage must never exceed the max. input voltage rating for the TriStar MPPT controllers (150V or 600V) under all circumstances. The worst-case scenario would be if the controller shuts

down during full power, high voltage operation. As indicated in the first section of this paper, the turbine's maximum Voc during unloaded operation (highest wind speeds) can never exceed the max. voltage rating of (150V or 600V) while it is connected to the TriStar MPPT controller, even if the transient is only microseconds in duration.

The TriStar MPPT controllers can shut down under many scenarios. The most susceptible time for a fault can be during the highest power and voltage levels. When the controller shuts down the sudden drop in power will create an inductive surge from the turbine which clipper circuits will not typically be able to respond to quickly enough to prevent transient voltages. All TriStar MPPT controllers include transient voltage surge protection (TVS) of 4500W which can get damaged from high power inductive surges associated with turbines. Damage of the TriStar MPPT TVS's is not covered under warranty. However, if the damage is limited it may be possible to replace the TVS's in the controller. Using a 20A fuse on the input can in some cases prevent more serious damage to the controller.

Metering devices will often not be fast enough to sense and an overvoltage surge which happens before the switch can make a connection. The TriStar MPPT includes daily logged data which includes the daily high input voltage. Daily logged data can be viewed with LiveView or downloaded with MSView™. If excessive input voltages are indicated the TVS's or other overvoltage protection may be protecting the TriStar MPPT controller to some extent. However, high voltages should be prevented before further operation as it will exceed the max. voltage rating of some components in the system.

It may be necessary to set switching to a lower voltage, prevent open circuit voltage surges with capacitors or have a faster solid state switch. Since there can be so many factors that can affect the voltage surges it is important that any overvoltage protection is engineered to be failsafe.

Low Voltage

The minimum operating input is slightly higher than the battery voltage. Therefore, the "cut-in" voltage of the turbine needs to be above the battery voltage. For example, it would not be practical to use a 24V nominal turbine with a 48V nominal battery.

The TriStar MPPT 600V controller also has a maximum input current that needs to be considered. The voltage vs. power curve should be able to be plotted below the maximum input current power levels shown in the Input Voltage vs. Battery Charging Power Graph (figure 3).

Over-Current Protection

Fusing the input of the TriStar MPPT controllers can help prevent the possibility of serious damage to the controller circuits in case of failed overvoltage protection. Recommended Breaker and Fuse ratings:

TriStar MPPT (150V) = Size input Fuse or Breaker current for Rated Output Current

TriStar MPPT (600V) = 20A (1 at the input of each controller for parallel input setup*)

* - Parallel input with TS-MPPT 600V is currently not available.

TriStar MPPT Wind Setup

The wind setup includes the following steps:

- 1) Custom Programming of the TriStar MPPT for Wind using the TriStar MPPT or TriStar MPPT 600V Setup Wizard in MSView™.
- 2) The Voltage vs. Power Curve will designate the Wind Tracking.

- a. Enter non-zero, positive values for input Voltage and Power with increasing power as voltage increases. It cannot be programmed to reduce the power at higher voltage levels.
- b. Not all 16 Voltage Power setpoints need to be used with V=0.00; P=0.0 for any unused pairs.
- c. The controller can operate above the highest voltage setting. It will continue to operate at the max. power setting up until the derated power at high voltage range or max. voltage shutoff.

Wind Mode - Setpoints

Enter the setpoints that define the power curve of your wind turbine.

	Voltage (V)	Power (W)
Lowest Voltage	0.00	0.0
	0.00	0.0
	0.00	0.0
	0.00	0.0
	0.00	0.0
	0.00	0.0
	0.00	0.0
	0.00	0.0
	0.00	0.0
	0.00	0.0
	0.00	0.0
	0.00	0.0
	0.00	0.0
	0.00	0.0
	0.00	0.0
Highest Voltage	0.00	0.0

Note: wind mode is only supported in v13 and later firmware and is currently in beta testing.

< Back Next > Cancel Help

Figure 5: MSView™; TriStar MPPT Setup Wizard - Voltage vs Power Setpoints Screen

3) Proper DIP Switch Settings.

- a. DIP Switch 1 activates the Wind Feature. (Voltage vs. Power Curve must be programmed first)
- b. The other DIP Switches operate according to the Solar PV Setup instructions.
 - i. Switch 3 activates the custom settings for the nominal voltage (24V, 36V, 48V, 60V) for the 600V. Switches 2&3 are used to set the nominal voltage (Auto,12,24,48) for the 150V.
 - ii. Switches 4-6 activate the Battery Voltage Regulation Presets or Custom Settings with 4-6 ON (UP).
 - iii. Note that the Battery Voltage Custom Setpoints are always programmed using 12V nominal voltages. It will be multiplied by 4 for 48V or according to the nominal voltage selected; for 24V(X2), [36V(X3) or 60V(X5) for the 600V].

Many Turbine manufacturers will have Voltage vs. Power curve information available.

Maximum open circuit voltage information may also be available from the manufacturer.

Morningstar does not currently have a list of turbines or manufacturers that have been verified to operate within the maximum voltage or power range of TriStar MPPT controllers.

Example System Programming with Logged Data:

Turbine: 1800 Watts max. power; 48V nominal Voltage
Rectifier includes a 120V dump load switch.

Programmed Voltage vs. Power Curve for TriStar MPPT (150V), Model: TS-MPPT-60 Controller:

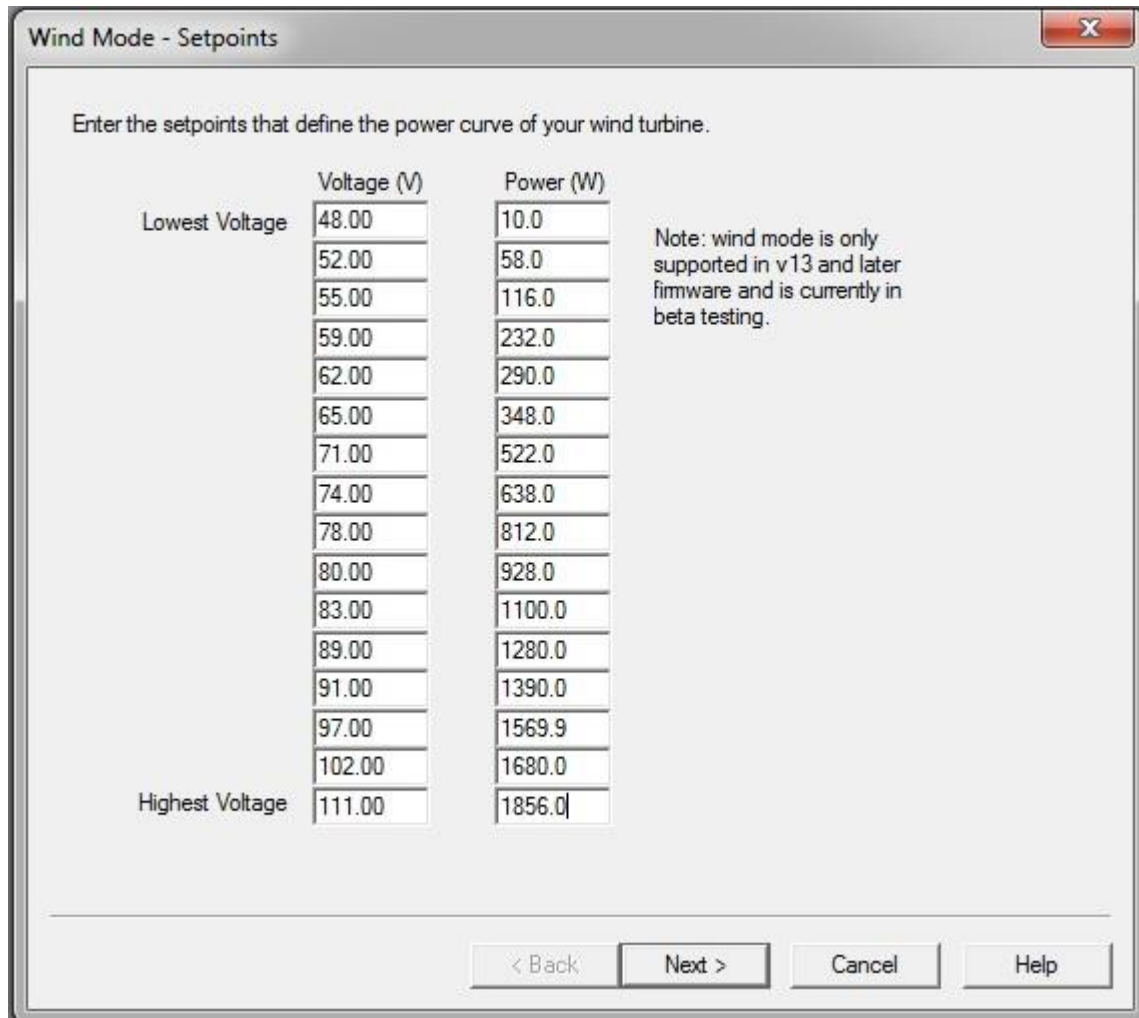

Figure 6: MSView™; TriStar MPPT (150V) Setup Wizard - Voltage vs Power Setpoints Screen Example

These points will create a Piecewise Linear curve shown in Figure 7.

Please note that for the TriStar MPPT 600V that the input current and power is not calibrated which can throw off the voltage vs. power curve to operate at higher power levels at lower voltages than it is programmed with. Please see Appendix: TriStar MPPT 600V Input Power Calibration info for Wind regarding this issue.

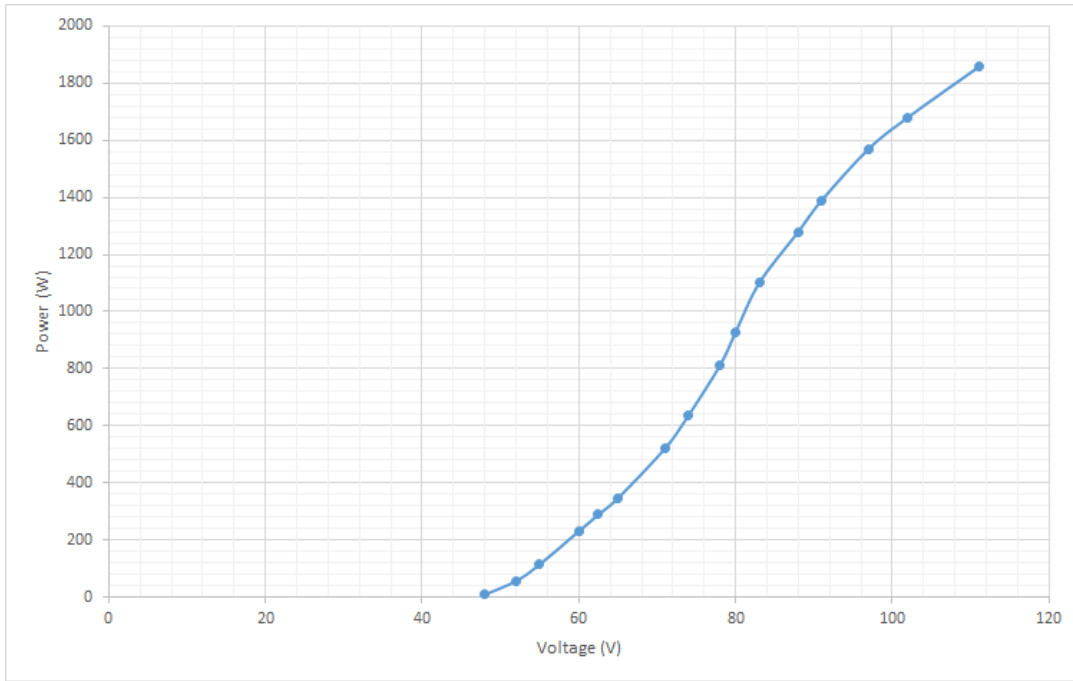

Figure 7: Graph of Voltage vs Power Piecewise Linear Curve

Plotting the V_{in} vs. Output Power from the system during operation results in Figure 8 shows a close correlation to the programmed Voltage vs. Power Curve.

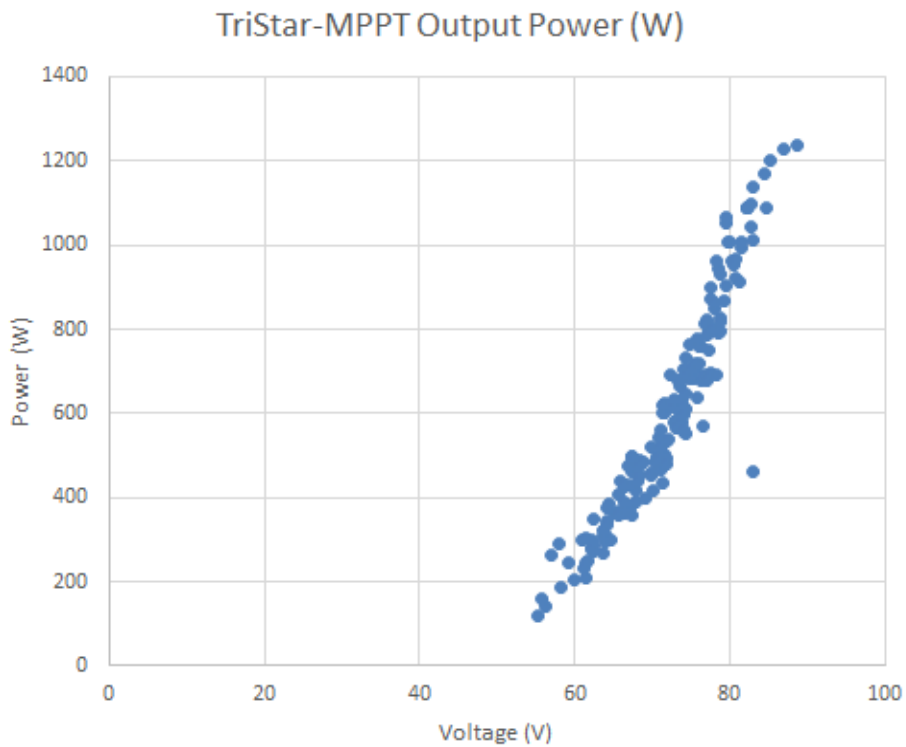
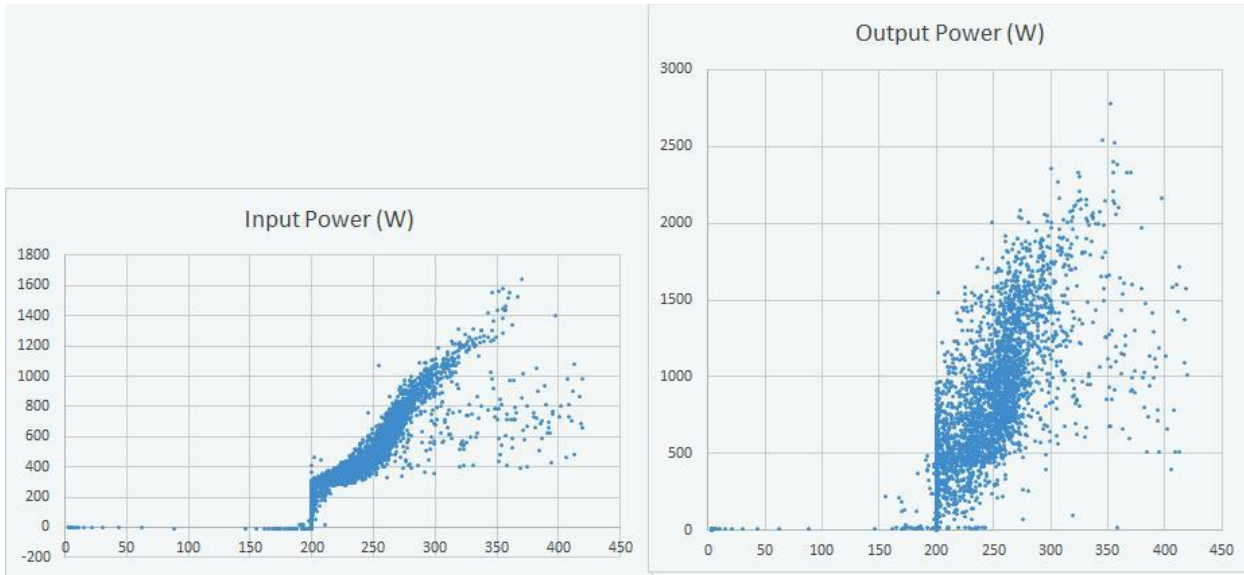

Figure 7: Scatter Plot Graph of Input Voltage vs Output Power During Operation

Appendix: TriStar MPPT 600V Input Power Calibration info for Wind



For more accurate tracking use $(.65 \pm .1) \times (\text{desired Power})$ for the Voltage vs. Power Curve.

Example: to operate with (150V, 1000W) use (150V, 650W)

Adjustment of input current limit to offset accuracy. Program below the Red Line to operate below the input current limit.

